

Installation Guidance Manual

Recommendations for the Successful Installation of
DorSuite Doorsets

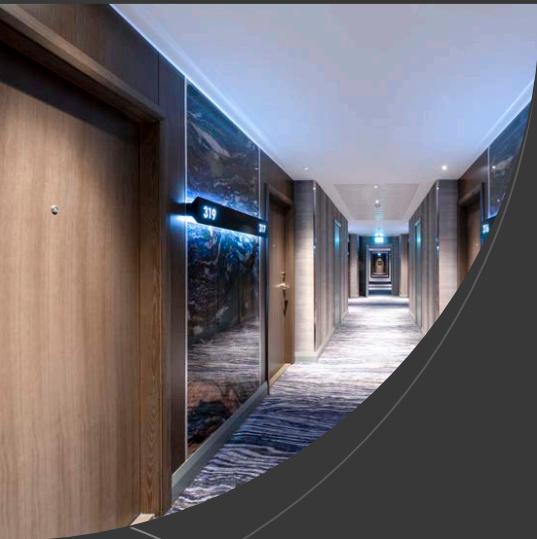

Certified. Compliant. Complete.

Contents

<u>Installer Qualifications</u>	3	<u>Door Stop Seal Arrangements</u>	14
<u>Handling, Storage & Protection</u>	3	<u>Threshold Seal Arrangements</u>	15
Handling	3	<u>UKCA/CE Marked Products</u>	16
Storage	3	<u>Fixing Points and Finishing</u>	16
Protection	5	Fixing Points	16
<u>Prime / Seal</u>	5	Finishing	17
<u>Heating the Building</u>	5	<u>Ancillaries</u>	17
<u>Before you start</u>	6	Over Panels	17
<u>Clearances</u>	6	Sliding Doors	18
Timber Doorsets	6	Extension Linings	18
Steel Doorsets	7	Modifications	19
<u>Recesses for Floor Mounted Closers</u>	7	Glazing	19
<u>Adjusting Door Sizes</u>	8	Air Transfer Grilles	19
<u>Fixing Requirements</u>	8	<u>Ironmongery Installation</u>	19
<u>Packer Material Requirements</u>	9	Installation Guidance Notes	20
Timber Frames	9	Flush Fitting Products	20
Metal Frames	9	<u>Replacement Parts</u>	20
<u>Back Filling Frame Requirements</u>	10	<u>BMTrada Q-Marking Scheme</u>	21
<u>Intumescent Mastic</u>	11	Plug Colours & Descriptions	21
<u>Basic Doorset Installation Steps</u>	11	Installation of Q-Mark Doors	22
<u>Special Installation Notes</u>	12	Non-Q-Mark Doorsets	22
Protect Suite Doorsets	12	Intumescent	23
Pyro Suite Doorsets	12	Ironmongery	23
Impact Suite Doorsets	13		
External Doorsets SBD	13		
Internal Doorsets Lead	13		
Lined Doorsets	13		

Installer Qualifications

It is strongly recommended that the installer is a member of a recognised quality assurance scheme to ensure that best practice is used. In respect of fire doors, inspection authorities may require evidence that the installation process complies with the tested specification including:

- Intumescent systems
- Compliance of the glazing with tested detail supplied by the door leaf manufacturer.
- The size of the operating gaps
- Intumescent protection around hardware and the quality of the preparations
- The quality of supporting construction and the prepared opening
- The fixing of the fire door
- Fire and smoke stopping methods used in filling in gaps and voids.

Handling, Storage and Protection

Handling

- Doors are a high-quality product and therefore require an appropriate level of protection on site. We recommend the packaging should not be removed until immediately before the doorsets are ready to be installed.
- Our products are late, second fix items and should be fixed after wet trades have finished on site when the moisture level in the building has returned to a normal level.
- Our products can be heavy and difficult to manoeuvre, so extra care should be taken to avoid damage to the product and prevent injury to site personnel. Always work in accordance with sites manual handling policy.
- Our products are designed for forklift truck off-loading and will be supplied banded in stacks for ease of distribution. Pairs of doors will be supplied packaged, separate to frames.

Storage

The correct storage conditions of the products are essential to ensure the product performs and appears as specified. Storage and protection of the products on site is the responsibility of the contractor.



Products should not be stored outside.

Please ensure that the following storage methods are adopted:

- Products should not be stored outside.
- Products should be stored close to the final installation area or in a location with the same moisture levels to allow the doorsets to acclimatise to the surrounding environment; ideally the products should be stored for 2-3 weeks in this location to allow the movement in the product to stabilise.
- Products should always be stored in a dry, enclosed location. The relative humidity of the storage area and the final installed location should fall within the range: 40-60% RH. Moisture content of our products is 10-12% for internal doorsets, and for external doorsets it will be 12-14%. Doors/doorsets stored outside of this range may swell or shrink and distort excessively, will invalidate guarantees and not perform as specified.
- Store in a well-ventilated area.
- Store close to the installation area.
- Stack doors/doorsets horizontally on 3-4 level bearers with bearers between the doors/doorsets. Bearers running the vertical length of the door are required if the doors/doorsets have long apertures. Bearers should line through with each other down the stack to stop doors being bent by the above load. Never put bearers across glass or glazing beads.
- Product should never be stacked straight on the floor.
- Doors should not be stacked more than 20 high and doorsets no more than 10 high.
- For extended storage periods, doors should be covered with black polythene to stop the finish being affected by ultraviolet light.
- When restocking door leaves, please ensure hinge knuckles or any other ironmongery is clear of the adjacent door face.

Relative Humidity Rating %	Effects
Below 40%	Materials are susceptible to "Case Hardening" where the cell structure of the material collapses resulting in deformation (bowing/warping) of the material structure.
40-60%	This level is the "Optimum" period to sustain conditioned manufactured joinery whereby Atmospheric Moisture is at "Equilibrium".
60-75%	Timber being "Hydroscopic" begins to absorb moisture resulting in expansion and destabilisation of the material
Above 75%	Materials are now exposed to high levels of atmospheric moisture. Deformation of the cell structure and uncontrolled excessive swelling resulting in size/shape alterations to the manufactured joinery, the details of which may not return to their original shape after atmospheric stabilisation.

Please note, even after these steps the doors / doorsets could still need adjusting when the building comes into use, as the environmental conditions will change.

Do Not:

- **Store outside**
- **Store on door frame/edge**
- **Store near heaters**
- **Store in areas colder than 3°C**
- **Store in direct sunlight**
- **Store in a damp area**
- **Stock product against walls**
- **Install prior to 2nd fix.**



Most of our doors and doorsets are dispatched to site shrink-wrapped. Whilst this gives a sensible level of transport protection, it must not be deemed as waterproof. The shrink-wrapping is perforated to allow the product to breathe.

Protection

It is essential to protect the doorsets after they are installed until the handover of the building. Our products are late second fix items, but other trades will still be passing through the doorways. The packaging removed from the doors/doorsets could be reused to protect the door facings and will give basic protection from paint and dirt etc., but it is the contractors responsibility to assess the level of protection required for the doorsets and provide it.

Adhesive tape should not be applied on to the door faces as this could damage the finish on the products. It may also cause natural veneer to fade or darken non-uniformly as areas of the door will be subjected to different levels of direct sunlight. Where the doors are subjected to a lot of sunlight, care must be taken as anything placed on the face of veneered doors could leave a silhouette as the veneer will fade or darken in direct sunlight.

Prime / Seal

To prevent ingress of moisture, doors must be primed and sealed within three days of reaching site and second coat applied within a reasonable period thereafter. Both the top and bottom edges of the door should be sealed. The label should not be painted over or removed.

Heating the Building

Heating of the building should be introduced solely over a long period. To achieve maximum air flow and to reduce the risk of uneven temperature build-up, doors should be left slightly

open with the closer arms disconnected. Doors held open with wedges against a door closer action will induce twisting.

Before you start

Make sure that you have the correct door/doorset in relation to the opening in which it is going to be installed; each product has a unique reference located on the label, which links with the contract drawings and schedules. This will help you match the correct door and frame later, where doors are stored to minimise site damage. Before removing the packaging, check the overall dimensions of the doorset will fit the opening it is intended for. If correct, remove all packaging, and take care to retain any loose items.

Where ironmongery is factory fitted, flush strike plates and flush bolt keeps may be attached to the door leaf or frame. You will need to remove these prior to installation.

When removing the product packaging, please use a packaging knife with a concealed blade, as this will reduce the risk of damaging the product when opening.

Timber frames supplied separately are fitted with a timber brace across the bottom – this will need to be removed.

In the case of single leaf doorsets where the doors are sent to site fitted in the frame, the door should be removed from the frame by either sliding the door off its hinges (if on lift off hinges), or by removing the screws from the frame hinge blades. The loose door leaves should be stacked horizontally as per the above storage information.

Clearances

Timber Doorsets

- Between the frame and door leaves (top and sides) – 4mm maximum (manufactured to allow 3mm)
- Between the door leaves at the meeting stile of double doors – 4mm maximum (manufactured to allow 3mm)
- From the bottom of the door to the finished floor covering – 10mm maximum for FD30 and FD60 doorsets; 5mm maximum for FD90 and FD120 doorsets.

Additional guidance on undercuts can be found in BS8214 but the following are guidelines recommended by DorSuite.

- Fire only doors – 10mm maximum undercut from the top of the finished floor covering to the underside of the door.

- Fire and smoke-controlled doors – 3mm maximum undercut from the top of the finished floor covering to the underside of the door. This can be increased up to 10mm with the use of a suitable threshold drop down seal. Dorsuite understand the tight tolerances specified by BS8214 for smoke-controlled doors and recommend that contact be made with Local Building Control or a Fire Officer to seek a solution agreeable to all parties prior to doorset manufacture commencing.

The outside door frame dimensions should be the coordinating height and width -5mm on each jamb and at the head (unless specifically requested otherwise) to allow door frames to be packed up to a few millimetres, if necessary, for the door leaf to swing over high spots of floor coverings.

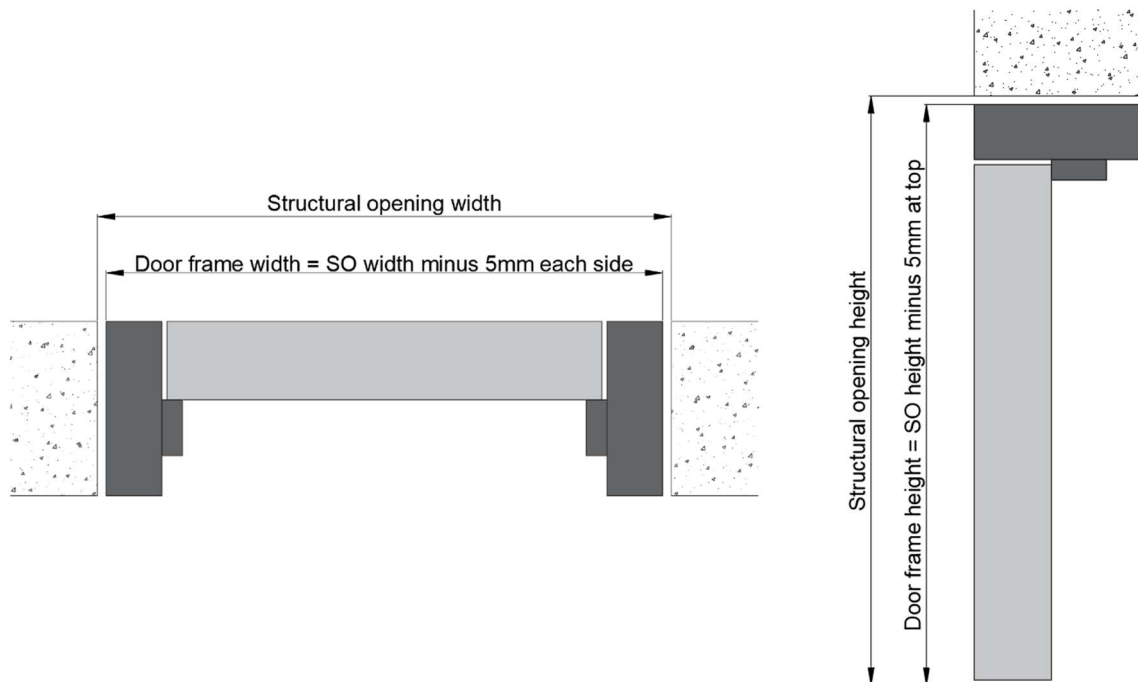

Steel Doorsets

- Between the frame and door leaves (top and sides) – 5.5mm maximum (manufactured to allow 3mm)
- Between the door leaves at the meeting stile of double doors – 5.5mm maximum (manufactured to allow 3mm)
- From the bottom of the door to the finished floor covering – 19mm maximum.

If no threshold seal is to be used, and the door is to stop cold smoke passage through the building, then the maximum gap from the bottom of the door to the finished floor covering is 3mm.

Recesses for Floor Mounted Closer Boxes

Plan pockets to receive closer boxes in reinforcement, floors, and screeds. The pockets must be formed and located with great accuracy to co-ordinate with the doorframe position. For projects where underfloor heating is employed the planning of closer boxes, within the floor construction, and consideration for fixing of doorstops in advance is critical.

Adjusting Door Sizes

All our doors are made to measure and cannot be cut down unless provisions have been allowed prior to manufacture.

Doors only may be purchased to go into existing openings, and these may need to be reduced to suit existing frames. The minimum lipping thickness allowed on our fire doors is 6mm and the maximum is 20mm, therefore a larger lipping will be required if doors are to be reduced on site.

Doors to go into frames or frames by other manufacturers will need the frames and any back filling checked for compliance with our fire certification.

If in any doubt, please check with our Technical Department before carrying out any work.

Fixing Requirements

To comply with our mechanical and fire test certification you are required to have fixings positioned no more than 150mm from the top and bottom of the door frame jambs and fixing through the jambs with a maximum spacing between them of 600mm and on frames over 1050mm wide an additional fixing is required to the centre of the frame head. On split frames, the section holding the door is required to be fixed in this manner, the secondary section can be fixed in any manner which securely fixes it in place.

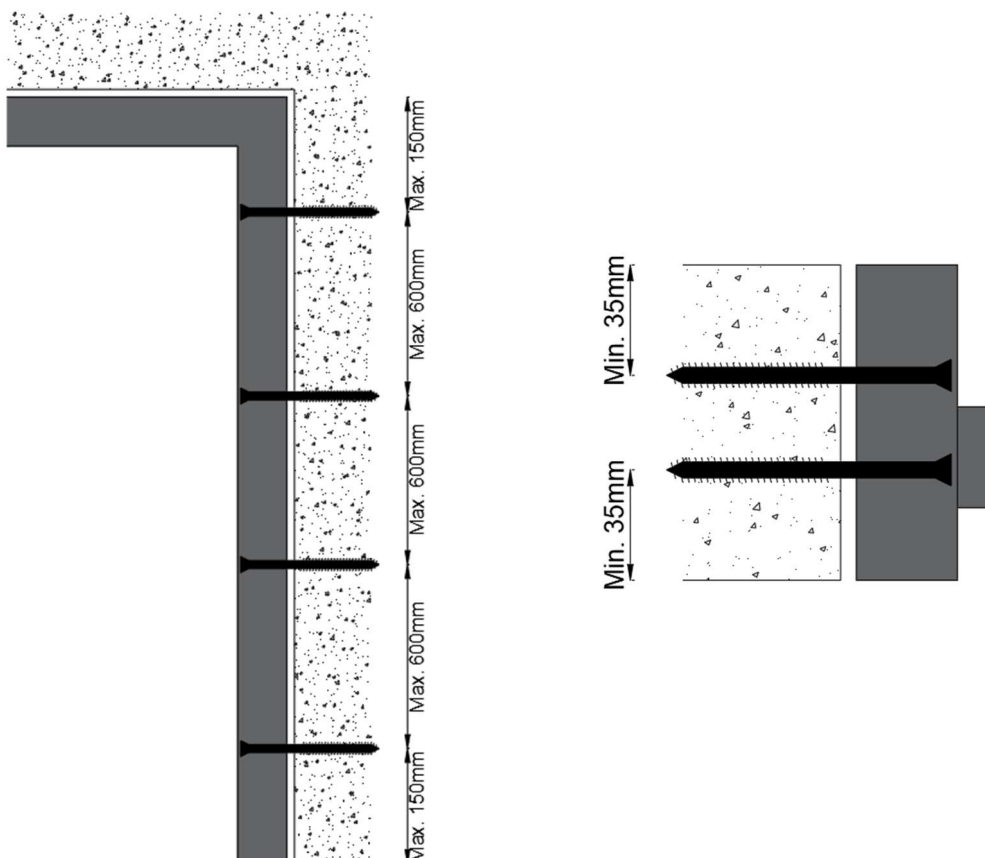

On heavy doorsets paired fixing will normally be required unless specialist fixings are used which are approved by the fixing manufacture for the door weight.

All fixings will need to be made into a solid material with a minimum of 45mm of anchorage into the wall construction (70mm for heavy doorsets). Soft mortar joints are not suitable fixing points as they will work loose with time.

Fixing should be kept in from the partition faces to stop the wall material breaking away; we recommend a minimum of 35mm.

Screws/bolts should have a minimum shank of no less than 4mm unless the fixing manufacturer states their fixings are suitable for the load to be applied to them.

Failure to follow our fixing recommendations may invalidate any guarantee, affect fire certification, or cause the products to not operate as specified.

Packer Material Requirements

Timber Frames

- NFR – Softwood/Ply/Plastic Packers/MDF
- FD30/FD60 – Fire rated packers (we recommend Certitek packers, with 10mm capping of Intumescent mastic)
- FD90/FD120 – Non-combustible material, for example, calcium silicate board or MGO board

Metal Frames

- NFR – Softwood/Ply/Plastic Packers/MDF/Steel
- All fire ratings – Steel/Non-combustible calcium silicate board/MGO board

Note: on our split frame constructions, a full-width packer is recommended as it will help to keep the second section in line with the first when fitting.

Pack between the door frame and the prepared opening immediately above each fixing position. Ensure that the door assembly, when in position, is perfectly plumb and square. Avoid later shrinkage of packers by using packers that are durable, hard, and stable. Proprietary trouser leg packers are best – Dorsuite recommends the use of Certitek Packers. Alternatives are off cuts of laminate, metal shims or plywood.

Ensure the frame jambs are straight, opening gaps are even and in tolerance and that fixing screws cannot distort the frame when tightened.

Note: the lateral force at the bottom hinge position can compress packers and metal studs causing the leading edge to drop. Before installing, ensure that studs are secure, and fillings are dry.

Packing pieces are not supplied by Dorsuite as part of the doorset.

Back Filling Frame Requirements

Internal Doorsets

Non-fire Rated: Back filling is not required – except for acoustic doorsets. For acoustic doorsets, 10mm Certitek mastic should be applied to both sides of the frame.

Fire Rated: See the following table for back filling requirements. Mineral Rock Fibre Wool to be used where noted.



BS EN 1366 - 4 : 2021

National Annex NA

Standard conditions for linear joint seal materials used to seal the gap between the back of timber fire doorset frames and the supporting construction.

Door Frame Material	Gap Width	Seal Depth	*Architraves	Backing	**Wall Type	EI 30	EI 60	EI 90	EI 120
Hardwood	20mm	10mm	NO	Mineral Wool	- Steel/Timber stud - Concrete/Masonry blockwork	✓	✓		
Hardwood	30mm	20mm	NO	Mineral Wool	- Steel/Timber stud - Concrete/Masonry blockwork	✓	✓	✓	
Redwood MDF Hardwood	20mm	10mm	NO	Mineral Wool	- Steel/Timber stud - Concrete/Masonry blockwork	✓	✓	✓	
Redwood MDF Hardwood	30mm	20mm	YES	Mineral Wool	- Steel/Timber stud - Concrete/Masonry blockwork	✓	✓	✓	
Accoya	10mm	20mm	NO	Mineral Wool	- Steel/Timber stud - Concrete/Masonry blockwork	✓	✓		
Redwood MDF Hardwood	10mm	10mm	YES	No Backing	- Steel/Timber stud - Concrete/Masonry blockwork	✓	✓		
Hardwood	10mm	10mm	NO	No Backing	- Steel/Timber stud - Concrete/Masonry blockwork	✓	✓		
MDF	20mm	10mm	NO	Mineral Wool	- Steel/Timber stud - Concrete/Masonry blockwork	✓	✓	✓	
Hardwood	10mm	10mm	YES	Mineral Wool	- Steel/Timber stud	✓	✓	✓	✓

* Minimum thickness 15mm

** The concrete/masonry blockwork should have a density greater than 350kg/m³. All walls should be previously tested to minimum 60 minute resistance and have a minimum thickness of 100mm

*** Provided doorset has been tested to this duration

Acoustic Rated:

- Gaps greater than 6mm require a bead of dense silicone sealant to a depth of 10mm around both sides of the frame perimeter.
- Gaps of 6-12mm require a dense packing of mineral wool and then capped off with a bead of silicone sealant to a maximum depth of 10mm around both sides of the frame perimeter.
- Remember sound is like water – seal all gaps or it will leak!

Intumescent Mastic

The specification for mastic must be as given in clause 9.4.2 in BS8214:2016, summarised below:

1. Test evidence for the mastic must be to the following standard: BS EN 1366-4 2021 (older standards are not acceptable). DorSuite recommends Certitek Fire Door Mastic DM-01.
2. Supporting test evidence must be for the required period of fire resistance or greater.
3. The sealant must have been tested over a minimum length of 1m, but this does not restrict its use in an application for a fire door of larger length.

Basic Doorset Installation Steps

1. Take the frame and offer it into the opening and level the head or transom rail. This is done by placing packers under the foot of the jambs or by altering the floor level, bearing in mind the required door undercut needed as this will lift or lower the door position.
2. Drill and fix the hanging jamb making sure it is plumb and free from bow and twist, always using packers behind the fixing points. You should have roughly an equal number of packers to both sides of the frame.
3. Drill and fix the lock jamb making sure it is plumb and free from bow and twist, and eye through the frame jambs to check they are parallel to each other. You may wish to put minimal fixings in at this point until the door(s) are re-hung as adjustment might be required.
4. On doorsets greater than 1050mm in width a fixing is required in the centre of the frame head to stop the frame head sagging.
5. Re-hang the door(s) in the frame.

6. Check you have a 3mm gap around the door(s) and it is flush with the frame. Adjust the packing as required to achieve this, making sure when done all fixings are in and have been tightened.
7. Back fill frame as per previous instructions.
8. Fix doorstops and architraves as required. On high traffic areas and on heavy doors without door closers, the doorstops will require to be glue fixed as well as pinned or screw fixed in place.
9. Fix loose doorstops after all adjustments have been made, allowing for the perimeter seal as necessary. Fit to the shape of the door leaf, permit easy latching action to ensure any seals are in correct contact with the door leaf face.
10. Doorstops can be pinned or screwed into position at centres that ensure that the doorstop is always in full contact with the door frame face.
11. Where wide doorstops are being used it may be necessary to apply parallel or staggered fixings to ensure a good fit.

Note: Where lift-off hinges are fitted architraves greater than 14mm in depth to the head of the frame must be set back sufficiently to allow the door to lift clear of the hinge pin.

Special Installation Notes

The following are some unique points you need to know regarding our more specialised products. These should be read in conjunction with the basic doorset installation guidance.

Protect Suite Doorsets

Please refer to the finger protection manufacturers installation instructions. A copy is available from DorSuite.

Pyro Suite Doorsets

Some Pyro Suite doorsets require a composite door frame (this will be shown on the door schedule) which is made of non-combustible mineral core to achieve the high fire performance. The material is strong but is also brittle and care is needed when moving the frames into position. The frame jambs can snap if too much force is used to bend/move them.

Door lever handles and pull handles should be fixed with bolt through fixings only.

Fix the architraves to the door frames with pins and glue.

Impact Suite Doorsets

Mitre cut the doorstop sections to the correct length, remove the loose PVC covers and affix the timber cores to the frame (remembering to allow a tolerance for the thickness of the PVC cover abutting the door face). Then fix the loose doorstop covers using the double-sided tape and adhesive provided. Press the PVC covers firmly in place over the timber sections to ensure a good adhesion. The double-sided tape should hold the PVC covers on until the adhesive sets.

Mitre cut one end of the architrave sections, then cut the other end to the correct length. Remove the loose PVC covers and affix the timber cores to the frame and fix the loose architrave covers using the double-sided tape and adhesive provided. Press the PVC covers firmly in place over the timber sections to ensure a good adhesion.

With the frame fixings hidden behind the doorstops and the doorstops and architraves fixed in this way there will be no visible fixings to be capped over.

For the best results all joints and abutments should be sealed with a colour-matching mastic.

For improved moisture resistance, please request the doors are capped top and bottom, the bottoms of the frames are capped and use silicone on site to seal all joints and abutments.

External Doorsets

Apply a bead of external grade silicone to the underside of the threshold and screw-fix kit. Ensure the threshold is level and parallel to the bottom edge of the door.

All recessing on external doors will require sealing to prevent moisture ingress.

Use stainless steel or nylon coated door ironmongery. On coastal or in very exposed areas use Grade 316 Stainless steel.

To prevent water ingress and heat loss the frame needs to be back filled with either mineral/glass wool or expanding foam and sealed with silicone on the outside face.

SBD Internal Doorsets

All essential ironmongery to this product will be fitted within out factory apart from the door closer. This will be supplied with the doorset for site installation with full fixing instructions supplied with the components. This product has prescribed ironmongery specification which must be used so as not to invalidate is SBD Certification.

Non-essential ironmongery such as door numbers, kickplates etc., can be glued or screw fixed to the doors, but you cannot fit any ironmongery which will remove door or frame material without our agreement as you could invalidate the certificate covering the product.

Lead-lined Doorsets

These doorsets are extremely heavy so extra care should be taken when handling.

Apply the lead backed architraves to the X-Ray room side so they overlap the gap between the frame and wall with the lead, and the plain architrave to the opposing side of the door frame by pin fixing or screwing.

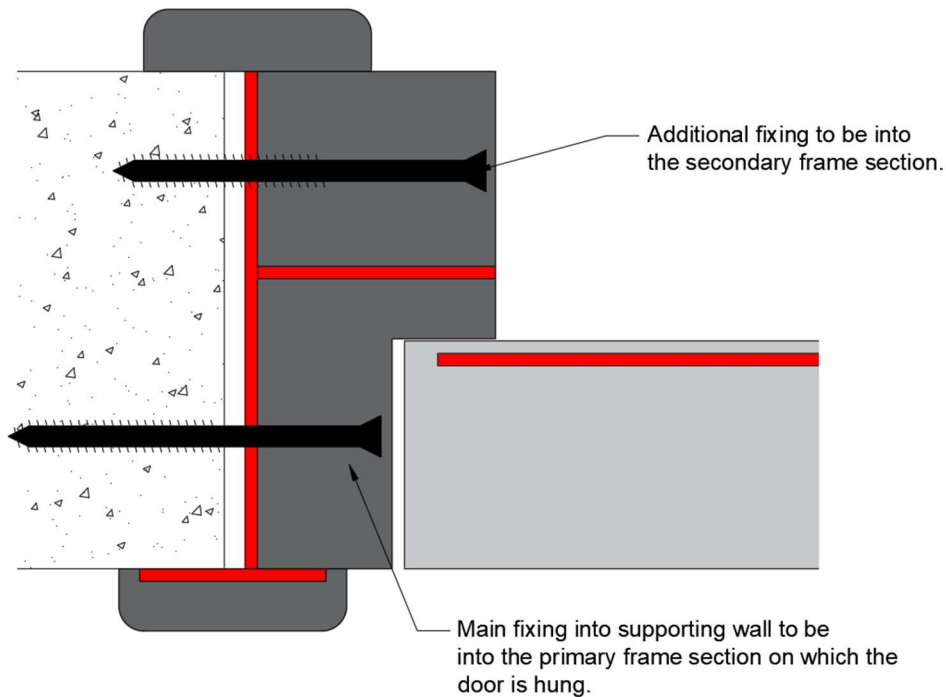

Doorstop Seal Arrangements

The standard perimeter doorstop seal supplied with our smoke rated doors and acoustic rated doors can be fitted in two different methods:

1. Compression Method

Apply the stop as normal with the door in the final closed position and then offer the stops up to the door face, ensuring an even gap of 3mm all around between the stop and face of the door. The self-adhesive seal (supplied loose to site) can then be fitted to the doorstop as shown below. The seal should make light contact with the door face. If the door face to stops gap is too tight or loose the performance of the doorset will be adversely affected. The seals should be mitre cut in the corners, so they butt up to the head/jamb seal neatly with no gaps. This is the preferred method of fitting the perimeter seals as it has no effect on the operation of the door.

2. Swipe Method

Fit the doorstop as normal with no additional gap for the seal. The self-adhesive seal (supplied loose to site) can then be fitted to the door frame adjacent to the doorstop as shown below. The seals should be mitre cut in the corners, so they abut the head/jamb seal neatly with no gaps. This method is usually only used when retrofitting the perimeter seal as it does have a small effect on the force required to open and close the door.

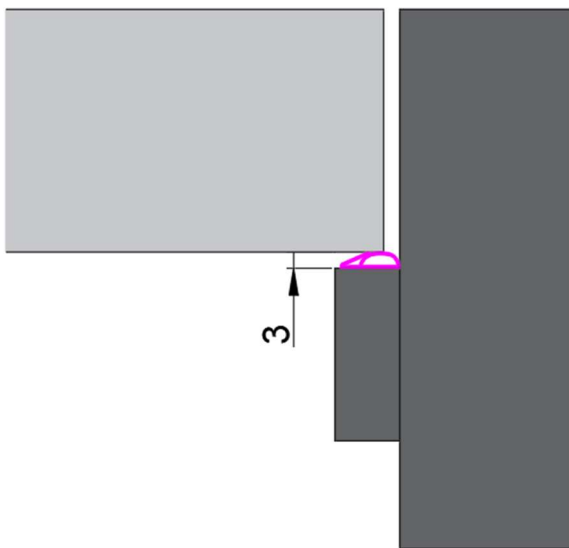

Compression Fitting Method – Seal fitted to the doorstop.

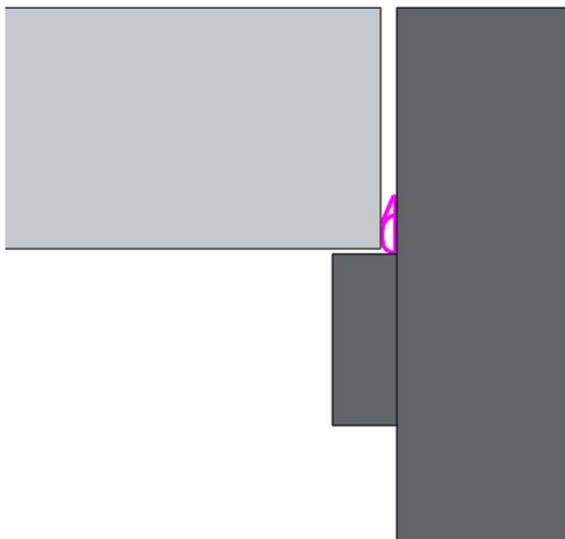

Swipe Fitting Method – Seal fitted to the frame.

Threshold Seal Arrangements

Where doorsets require threshold seals for cold smoke control and acoustic performance, our most common design is to add a drop-down seal to the bottom of the doors, as shown below.

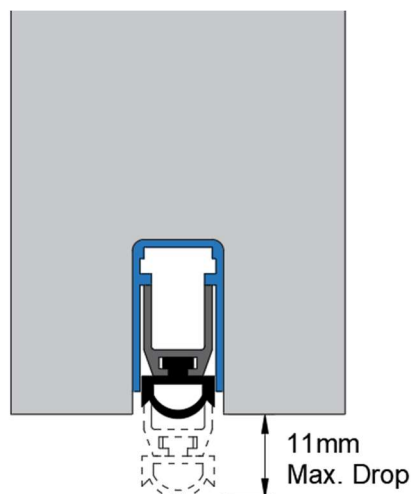

Drop seals are best suited to solid, smooth floor surfaces to ensure maximum contact. While a certain amount of unevenness in the floor finish can be absorbed by the seal, if the surface below the seal is particularly bad, or there is a soft floor covering (for example, carpet), a threshold bar will be required to be fitted to ensure the seal has contact across the full width of the door. The maximum drop on the standard drop seal is 11mm and should be considered when specifying the door undercuts.

UKCA/CE Marked Products

If we supply an external UKCA/CE marked product, all the essential ironmongery to this product will be fitted within our factory apart from the door handles, thresholds, and door closer if required. These will be supplied with the doorset for site installation with full fixing instructions supplied with the components. These products have a prescribed ironmongery specification which must be used so as not to invalidate the UKCA/CE Certificate.

Non-essential ironmongery such as door numbers, kickplates etc., can be glued or screw fixed to the doors, but you cannot fit any ironmongery which will remove door or frame material without our agreement as you could invalidate the certificate covering the product.

Fixing Points and Finishing

Fixing Points

As standard our frames are left un-drilled for site drilling but can be supplied bore and counter bored if specifically requested. Pellets can also be provided if requested. These will be supplied bagged separate to the frames.

Screw fixings to lacquered timber frames will require pellets to be fitted. These are glued and hammered in over the fixing point, making sure the grain direction matches the frame. However, please note timber is a natural product and therefore the colour and grain pattern may vary from frame to frame, the pellets will therefore need matching to the frame for the best possible match.

Screw fixings to primed timber frames can be finished as above with pellets or filled with a non-shrinking wood filler, sanded flat and painted over.

Pin fixings to lacquered timber stops and architraves should be filled with a matching-coloured wax or coloured wood filler.

Pin fixings to painted timber stops and architraves should be filled with a non-shrinking wood filler. (Decorators caulk is not suitable.) Steel frames will be prepared for fixing holes and supplied with cover caps.

Finishing

Where products are to be painted on site, they will be delivered factory primed and will require de-nibbing by lightly sanding before painting. Factory primed doors may require undercoating and multiple topcoats; consult your decoration specification. Top and bottom edges of doors must be painted.

Where products are fully painted, extra care should be taken when handling on site. Fully painted frames should have all fixing points concealed behind the stops and seals where possible. Stops and architraves will need to be pin fixed. We cannot accept any responsibility for any touch up works required due to site or installation damage.

Ancillaries

Over panels

Where possible over panels are supplied factory-fitted within the frame of doorsets, however, with some doorsets this may not be practical due to weight and size. In these cases, the over panel will be supplied factory prepared for site fixing and delivered separately. The over panels require installation prior to frame installation.

The over panel should be positioned so it will line through with the door leaf. Secure the panel by drilling and screwing it through the back of the frame with fixings 100mm in from the corners then fixing no greater than 250mm apart across the top and sides and across the transom (if fitted). Use a 4mm shank diameter screw and the screw should have 30mm of anchorage into the over panel.

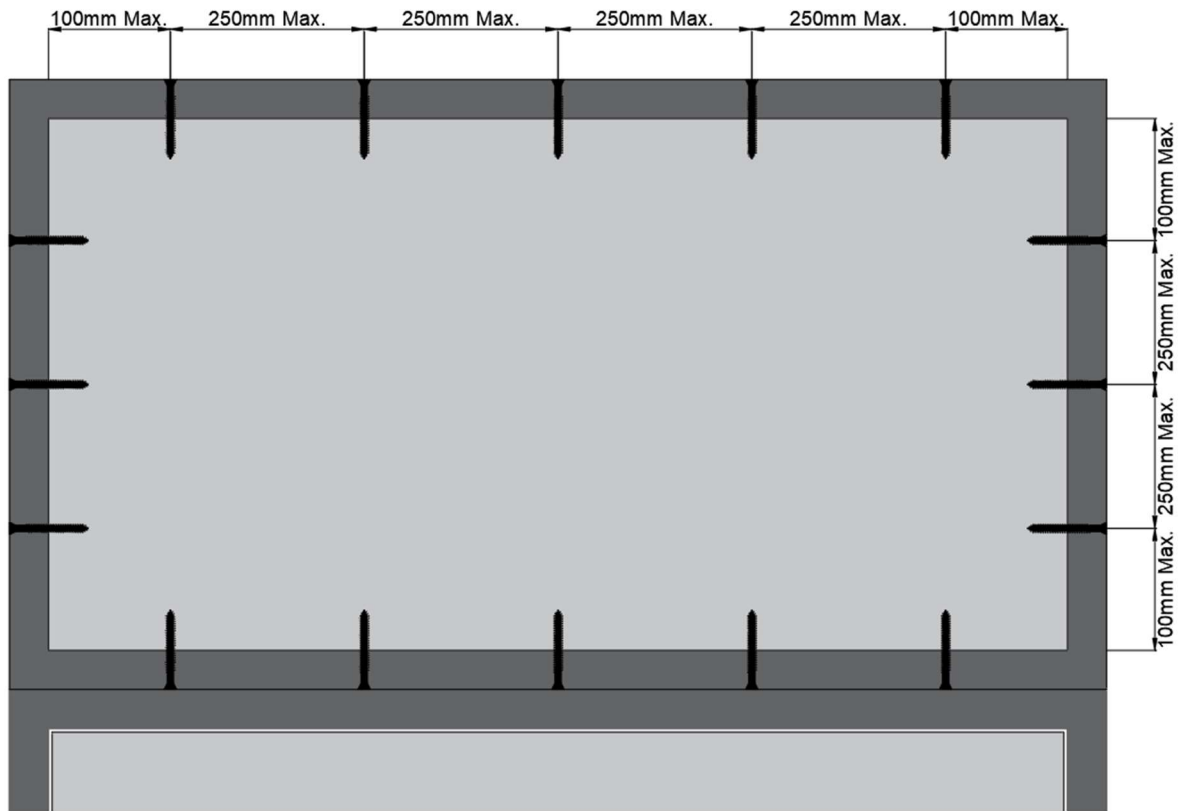

Sliding Doors

Fit in accordance with the installation instructions supplied by the sliding track manufacturer. Where the opening of the wall is lined with a plain frame lining, this should be fixed in the same method as a standard frame (unless otherwise specified by the sliding track manufacturer).

Extension Linings

Most extension linings fit into a groove on the frame and can be pulled in or out slightly to suit the partition thickness. For performance reasons on some frame types, we cannot groove the frame for the extension lining and they will need to be butt jointed to the frame.

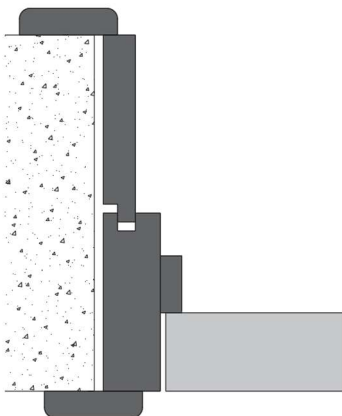

The extension lining is normally screw fixed in the same way as the frame and this would be our recommendation but as this element does not affect the fire rating it can also be bonded in place. Extension linings do not need to be back filled. Ensure the main frame section is back filled prior to fixing the extension lining in place.

Modifications

Any alteration of our doorsets, including Glazed apertures, machining, fitting of air transfer grilles, trimming of doors, removal of hinges or intumescent or factory fitted ironmongery, may void the certification, and invalidate the fire rating. If in doubt, please check with DorSuite.

Glazing

Apertures cannot be cut into our fire rated doors on site. We strongly recommend that all aperture preparation is carried out in our works and cannot accept responsibility for later problems caused by site cutting of apertures. Some of our doors have metal linings to their cores or require special framing prior to manufacture.

It is strongly recommended that all Vistamatic products are installed on site after the door has been installed. This is to prevent damage to the glazed units in transit.

Air Transfer Grilles

Fire doors can be fitted with air transfer grilles that have been fire tested and assessed. Air transfer grilles must be installed in accordance with the manufacturer's installation instructions. Apertures cannot be cut into our fire rated doors on site. Non-fire rated doors can have apertures cut, but we would advise that you check on the door construction prior to starting any work as some of our doors have metal or loose bonded cores which could give rise to problems on site.

Ironmongery Installation

We recommend the following is always considered prior to proceeding with any installation and/or fixing of ironmongery not supplied by DorSuite onto DorSuite doorsets.

- Ironmongery falls into two specific categories – essential and non-essential.
- Essential ironmongery is required to enable the doors to perform its fire resisting function.
- Non-essential ironmongery may be needed to enable other functions to be achieved, but the elements involved could prejudice fire resistance.
- It is therefore vitally important to consider the influence that all ironmongery may have on fire resistance and establish that products being used/considered are compliant.

Installation Guidance Notes

- Please take care to unpack all contents ensuring no loose items are lost/discarded, particularly any intumescent protection that has been supplied loose. These must be installed to maintain the fire certification.
- Care should be taken to ensure that when installing ironmongery with the use of battery-operated tools, the correct torque settings are applied to the tools to minimise the risk of over tightening or spinning of screw fixings.
- Ironmongery to be fitted in accordance with the ironmongery manufacturer's instructions and our product data sheet that is provided with each door/doorset, as this identifies maximum dimensions, material specification and intumescent protection.
- Take care when installing ironmongery to Pyro Suite doorsets. This product may have a mineral based core and screw threads are liable to break up the construction if they are removed or replaced repeatedly. See Pyro Suite doorset section for specific advice.
- When positioning a hold open device please make sure you place the hold open unit, so it aligns with the position of the door closer, either at the top or bottom of the door. This ensures that if the door is held open for prolonged periods, danger of the door twisting will be reduced.
- Some FD30 and all FD60 and above doorsets require intumescent protection to hinges to meet fire certification. If not fitted, the fire certification will be invalidated.
- Some FD30 and all FD60 and above doorsets, the door lock keeps are to be bedded on 1mm interdens/graphite to meet fire certification.
- When fitting concealed door closers such as Geze Boxer or Dorma ITS96, please ensure the supplied intumescent/seal packs are fitted as instructed. This is critical to achieving the product's fire rating. Without fitment of the intumescent in the door and frame, certification is invalid. The door and/or door frame constructions will need to have been upgraded to receive this type of ironmongery to meet fire certification and mechanical strength test data.

Flush Fitting – Flushbolts/Locks

If installing any flushbolts or locks not supplied by DorSuite into fire rated doors, please ensure that all the intumescent materials are fitted around the product as identified in the product data sheet. Please ensure items comply with all rules stated in product data sheets.

All ironmongery should be CE marked on fire rated doorsets.

Replacement Parts









Doorset parts, for example seals and ironmongery etc, can get damaged or worn out. This can compromise the doorset performance and correct sourcing of acceptable replacement parts is crucial. Do not assume all products with the same generic description will all work the same. Please contact DorSuite for details of any replacement components you may require.

BM Trada Q-Marking Scheme

DorSuite Certificate of Registration: 1122

Below are identification details for doors provided by DorSuite to the BM Trada Q-Mark Scheme.

Plug & Insert Colours / Descriptions:

Component	Description
 Yellow Outer	FD30 Fire Integrity. Used for partial or complete doorsets
 Blue Outer	FD60 Fire Integrity. Used for partial or complete doorsets.
 Brown Outer	FD90 Fire Integrity. Used for complete doorsets.
 Black Outer	FD120 Fire Integrity. Used for complete doorsets.
 Red Insert	Door Leaf / Frame requires additional site preparation (intumescent strips / hardware preparation).
 Green Insert	Door Leaf / Frame requires additional site preparation (hardware preparation).
 Orange Insert	Additional plug to denote Factory Glazed Door.
 Silver Insert	Complete factory hung doorset – all ironmongery and intumescent seal preparations have been made (ironmongery may be site fitted) All ironmongery and intumescent seals must be supplied by DorSuite.

Plugs are generally positioned below the top hinge/pivot on the door leaf. However, where this is not practical the plugs will be positioned at the head of the door leaf.

Some examples of how this would look on the doors are shown below:

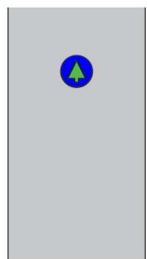

FD60 Fire Integrity, Flush Door Leaf only or complete doorset. Requiring additional site hardware preparation.

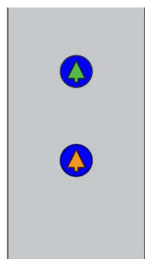

FD60 Fire Integrity, Factory Glazed Door Leaf only or complete doorset. Requiring additional site hardware preparation.

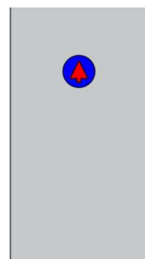

FD60 Fire Integrity, Flush Door Leaf only or complete doorset. Requiring additional site intumescent and hardware preparation.

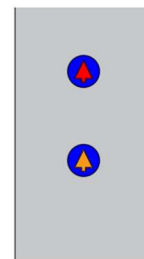

FD60 Fire Integrity, Factory Glazed Door Leaf only or complete doorset. Requiring additional site intumescent and hardware preparation.

Installation of Q-Mark Fire Doorsets

1. The Gold plug is inserted by the doorset installers and must only be fitted to a Q-Mark Certified fire doorset, identified as such by having a Silver Tree plug fitted to the door leaf.
2. If the door leaf has glazing fitted but an Orange Tree plug has not been fitted to the door leaf, or if sidelight/fanlight glazing is present but not all component parts/full installation instructions were supplied then regardless of any other plugs fitted, the doorset cannot be confirmed as Q-Mark certified and the Gold Tree installation plug cannot be fitted.
3. Whenever the installed doorset is included within a Record of Installation Activities, it must either have a Gold plug or Gold label affixed.
4. Whenever a Gold plug or a Gold label is affixed to a doorset it must be included within the Record of Installation Activities.
5. A Gold Installation plug must be installed where the doorset is identified as being a complete Q-Mark approved doorset. It is not acceptable to just affix a Gold installation label.
6. A Gold Installation label can be used in addition to the Gold Installation plug to a Q-Mark certified doorset if required.

Non-Q-Mark Manufactured Doorset Installation Label Options

This includes (but is not limited to):

- Q-Mark Doors marked with Green or Red Trees
 - Doors manufactured by a Q-Mark manufacturer that are out with the Q-Mark scope.
 - Doors manufactured (or, for example, glazed) by a Non-Q-Mark manufacturer.
1. Where the doorset being installed is not Silver Plugged and meets the criteria noted above the doorset cannot be fitted with Q-Mark Gold plug.
 2. A Gold Fire Door Installer label bearing the company's certificate number must be attached to any door leaf, door frame or doorset that is listed on the Record of Installation Activities where the fitting of a Gold Installation plug is not applicable, but the Installer is working under the Q-Mark scheme requirements.

Intumescent

Where a Green or Silver inner plug is present, the seals provided by DorSuite must be used. Any replacing or removal may invalidate the certification.

Where a Red inner plug is present, intumescent strips must be fitted to the door or frame perimeter; the number of strips used, and type is dependent on the door size and configuration. Please see relevant Doorset Field of Application for confirmation of the intumescent that is applicable.

If in any doubt, approved intumescent manufacturers and types can be found by contacting DorSuite.

Ironmongery

If the door or frame carries a Green or Red inner plug, then the Ironmongery used must comply with the relevant Field of Application reports.

The Field of Application that relates to your order will be included in the O&M Documentation. It is also available on request.

If a factory hung doorset has been supplied and carries a Silver Inner plug, then only the ironmongery supplied with the doorset may be used.

Removal or substitution may invalidate the fire rating and certification.

Please follow the manufacturer's instructions for correct installation of ironmongery.